



Designated according to The Construction Products (Amendment etc.) (EU Exit) Regulations 2020

UK Technical Assessment	UKTA-0836-of 22/6348 11/11/2022
Technical Assessment Body issuing the UK Technical Assessment:	British Board of Agrément
Trade name of the construction product:	RAWLPLUG Insulation System R-TFIX-8S
Product family to which the construction product belongs:	Area Code: 33 Plastic anchors for fixing of external thermal insulation composite systems with rendering in concrete and masonry
Manufacturer:	Rawlplug S.A. Ul. Kwidzyńska 6 51-416 Wrocław Poland
Manufacturing plant(s):	Rawlplug S.A.
This UK Technical Assessment contains:	19 pages including 3 annexes which form an integral part of this assessment
This UK Technical Assessment is issued in accordance with The Construction Products (Amendment etc.) (EU Exit) Regulations 2020 on the basis of:	UKAD 330196-01-0604 <i>Plastic anchors made of virgin or non-virgin material for fixing of external thermal insulation composite systems with rendering</i>

Communication of this UK Technical Assessment, including transmission by electronic means, shall be in full. However, partial reproduction may be made with the written consent of the British Board of Agrément. Any partial reproduction must be identified as such.

1 Technical description of the product

The screwed-in anchor R-TFIX-8S consist of an anchor sleeve with enlarged shaft, an insulation plate manufactured from polypropylene and special screw or over moulded screw manufactured from of galvanized steel or stainless steel as expansion element. The expanding part of the anchor sleeve is slotted.

For the surface mounting the anchor may in addition be combined with the anchor plates KWL 090, KWL 110, KWL 140.

For the countersunk mounting the anchor may in addition be combined with the anchor plates KWX 110 or KWX 63.

The anchor is installed in drilled hole by screwing the expansion element into the anchor sleeve.

The illustration and the description of the product are given in Annex A.

2 Specification of the intended use(s) in accordance with the applicable UK Assessment Document (hereinafter UKAD)

The performances given in Section 3 are only valid if the anchor is used in compliance with the specifications and conditions given in Annex B.

The provisions made in this UK Technical Assessment are based on an assumed working life of the anchor of 25 years. The indications given on the working life cannot be interpreted as a guarantee given by the producer, but are to be regarded only as a means for choosing the products in relation to the expected economically reasonable working life of the works.

3 Performance of the product and references to the methods used for its assessment

3.1 Mechanical resistance and stability (BWR 1)

Not relevant.

3.2 Safety in case of fire (BWR 2)

Not relevant.

3.3 Health, hygiene and the environment (BWR 3)

Not relevant.

3.4 Safety and accessibility in use (BWR 4)

Essential characteristic	Performance
Characteristic resistance under tension loads	See Annex C 1
Displacement	See Annex C 1
Plate stiffness	See Annex C 2

3.5 Protection against noise (BWR 5)

Not relevant.

3.6 Energy economy and heat retention (BWR 6)

Essential characteristic	Performance
Point thermal transmittance	See Annex C 2

3.7 Sustainable use of natural resources (BWR 7)

No performance assessed.

4 Assessment and verification of constancy of performance (hereinafter AVCP) system applied

4.1 System of assessment and verification of constancy of performance

According to UKAD No. 330196-01-0604 and Annex V of the Construction Products Regulation (Regulation (EU) 305/2011 as brought into UK law and amended, the system of assessment and verification of constancy of performance (AVCP) 2+ applies.

5 Technical details necessary for the implementation of the AVCP system, as provided for in the applicable UKAD

Technical details necessary for the implementation of the AVCP system are laid down in the control plan deposited with the British Board of Agrément and made available to the UK Approved Bodies involved in the conformity attestation process.

5.1 UKCA marking for the product/ system must contain the following information:

- Identification number of the Approved Body
- Name/address of the manufacturer of the product/ system
- Marking with intention of clarification of intended use
- Date of marking
- Number of certificate of constancy of performance
- UKTA number.

On behalf of the British Board of Agrément



Date of Issue: 11 November 2022

Hardy Giesler
Chief Executive Officer



British Board of Agrément,
1st Floor Building 3
Hatters Lane
Croxley Park
Watford
WD18 8YG

ANNEXES

This annex applies to the product described in the main body of the UK Technical Assessment.

R-TFIX-8S

Surface assembly

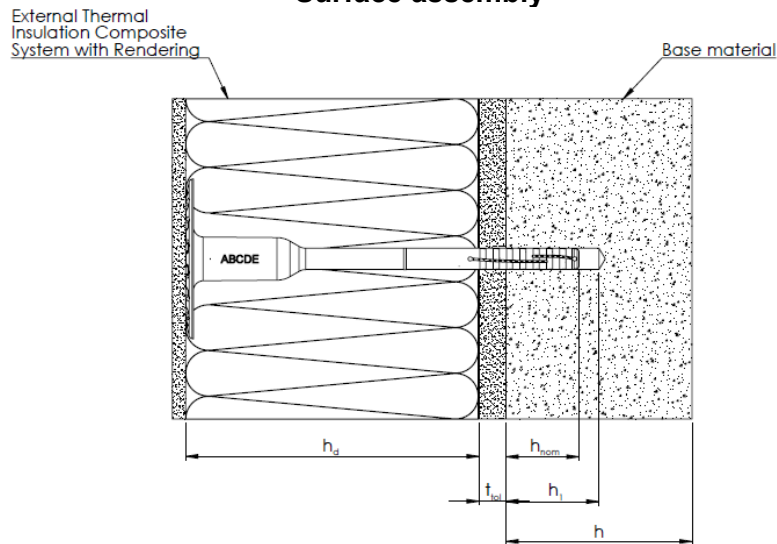

Countersunk assembly

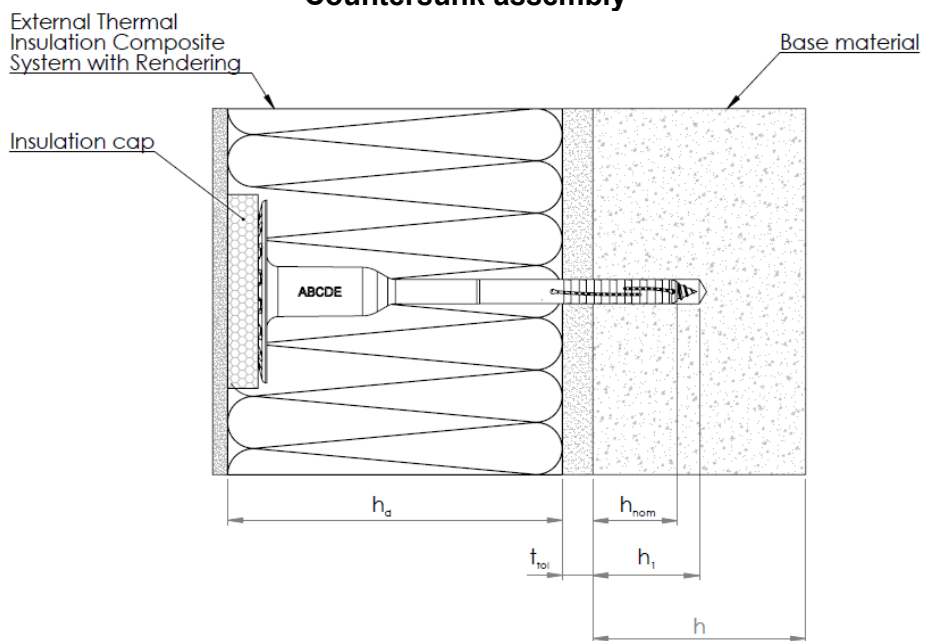

- h_{nom} = overall plastic anchor embedment depth in the base material
- h = thickness of member (wall)
- h_1 = depth of drilled hole to deepest point
- h_d = thickness of insulation material
- t_{tol} = thickness of equalizing layer or non-load-bearing coating

RAWLPLUG Insulation System R-TFIX-8S

Product description
Installed conditions

Annex A 1

**R-TFIX-8S – surface assembly
Anchor sleeve**

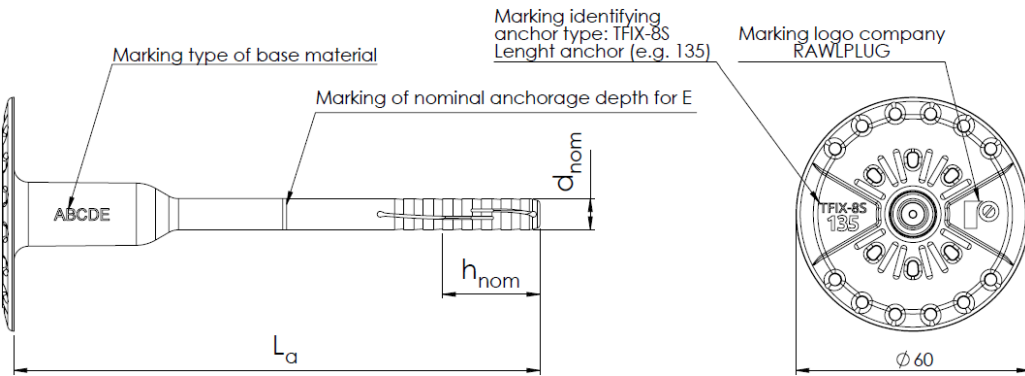

Over moulded screw

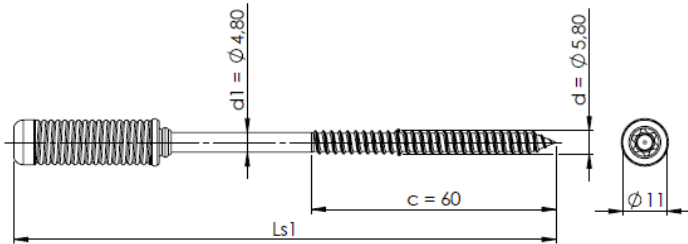

Screw

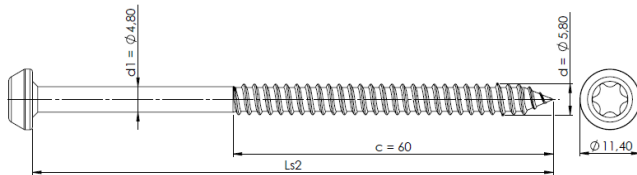

Insulation cap

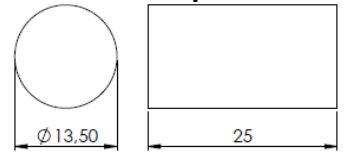

Material	EPS
Colour	White, grey

For proper assembly you can use setting tool (Annex B 5) or standard Bit.

Table A1: Dimensions

Anchor type	Anchor sleeve			Screw		
	h _{ef} [mm]		Ød _{nom} [mm]	L _a [mm]	L _{s1} [mm]	L _{s2} [mm]
Use category	A, B, C, D	E				
R-TFIX-8S	25	65	8	135 - 455	115 - 455	80 - 420

Determination of max. thickness of insulation:

$$h_d = L_a - t_{tol} - h_{nom}$$

e.g. $L_a = 135 \text{ mm}$, $t_{tol} = 10 \text{ mm}$, $h_{nom} = 25 \text{ mm}$, $h_d = 135 - 10 - 25 = 100 \text{ mm}$

Table A2: Materials of anchor R-TFIX-8S

Designation	Colour	Material
Anchor sleeve	Natural, white, red, grey, yellow, black, blue, green, orange	Virgin plastic - Polypropylene
Expansion screw	Natural	Galvanized steel or stainless steel
Over moulded expansion screw	Natural - screw Natural, black, grey – over moulding	Galvanized steel or stainless steel with glass fibre reinforced polyamide over moulding

RAWLPLUG Insulation System R-TFIX-8S

Product description
Dimensions and materials

Annex A 2

**R-TFIX-8S – countersunk assembly
Anchor sleeve**

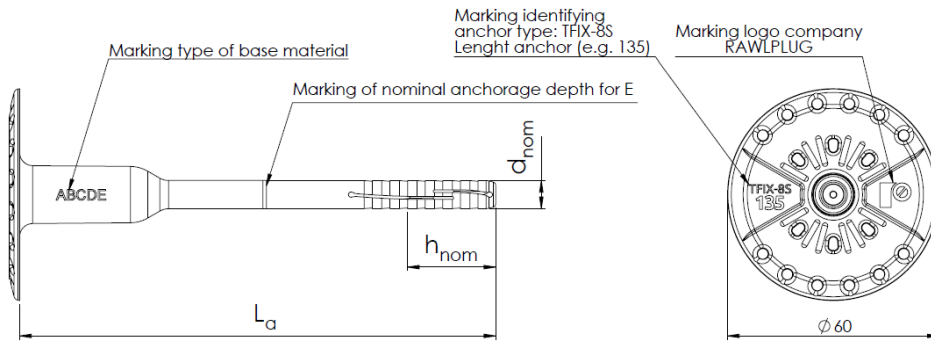

Over moulded screw

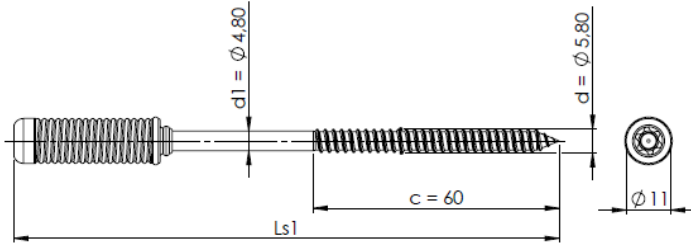

Screw

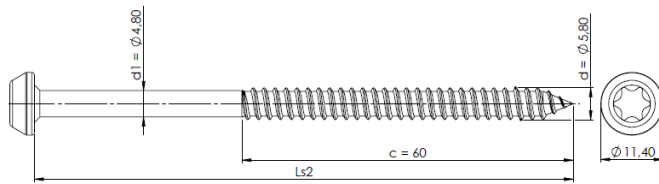

Insulation cap

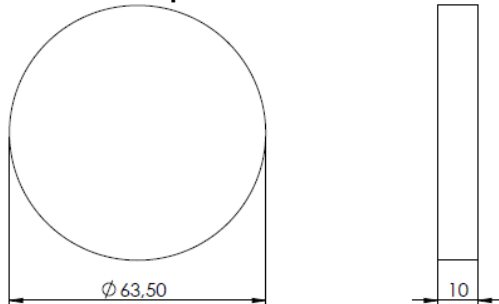

Material	Colour
EPS	White, grey
Mineral	Natural

For proper assembly use setting tool (Annex B 5).

Table A3: Dimensions

Anchor type	Anchor sleeve			Screw			
	h _{ef} [mm]		Ød _{nom} [mm]	L _a [mm]	L ₁ [mm]	L ₂ [mm]	Ød [mm]
Use category	A, B, C, D	E					
R-TFIX-8S	25	65	8	135 - 455	115 - 455	80 - 420	5.8

RAWLPLUG Insulation System R-TFIX-8S

Product description
Dimensions

Annex A 3

Additional plates

KWL 90

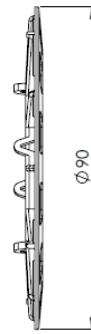
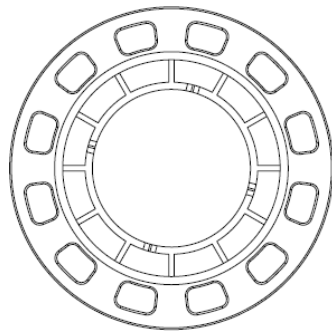

KWL 110

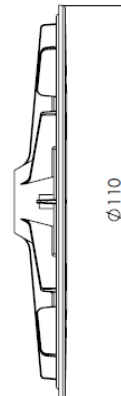
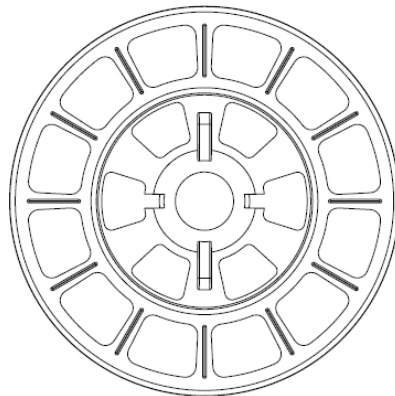

KWL 140

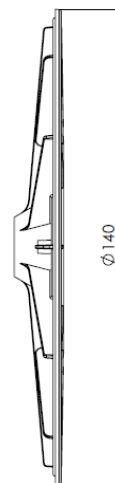
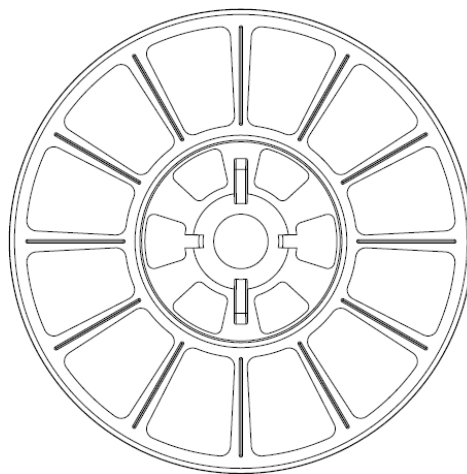

Table A4: Materials of additional plates

Plate	Diameter	Colour	Material
KWL 90	90	Natural, white, red, grey, yellow, black, blue, green, orange	Virgin plastic PA6 + GF, PP
KWL 110	110		
KWL 140	140		

RAWLPLUG Insulation System R-TFIX-8S

Product description
Additional plates

Annex A 4

Additional plates

KWX 63

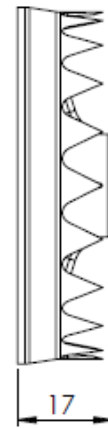
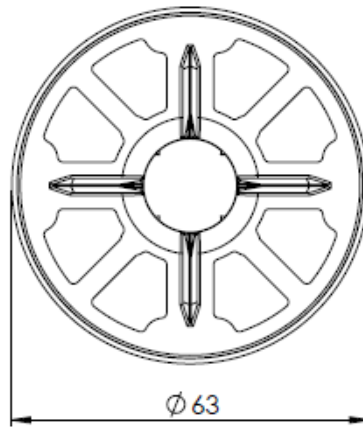

KWX 110

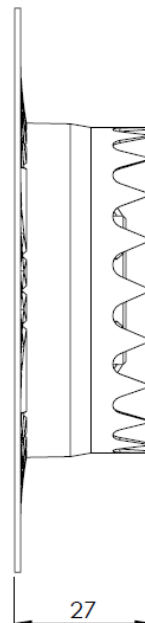
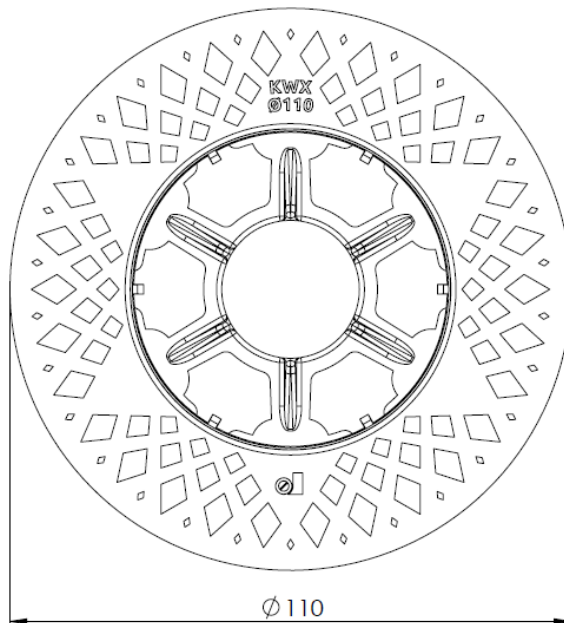

Table A5: Materials of additional plates

Plate	Diameter	Colour	Material
KWX 63	63	Natural	Virgin plastic
KWX 110	110		PP+GF; PA+GF

RAWLPLUG Insulation System R-TFIX-8S

Product description
Additional plates

Annex A 5

Specifications of intended use

Anchorage subject to:

- Multiple fixing for the anchorage of bonded external thermal insulation composite systems (ETICS)."

Base materials

- Reinforced or unreinforced normal weight concrete (Use category A), according to Annex B6.
- Solid brick (Use category B), according to Annex B6.
- Vertically perforated clay bricks POROTHERM 17,5 P+D according to EN 771-1 (Use category C), according to Annex B6.
- Lightweight aggregate concrete hollow blocks LAC (Use category D), according to Annex B6.
- Autoclaved aerated concrete AAC 4 (Use category E), according to Annex B6.
- The characteristic tension resistance of the anchor may be determined by means of job site tests according to EOTA TR 051, edition December 2016, carried out on the material actually used, if a characteristic resistance of the base material does not exist (for example masonry made of other solid masonry units or made of perforated clay bricks).

Use conditions

- The anchor may only be used for transmission of wind suction loads and shall not be used for the transmission of dead loads of the thermal insulation composite system. The dead loads have to be transmitted by the bonding of the thermal insulation composite system.

Use categories:

- A, B, C, D and E.

Design:

- The design of anchorages is carried out in compliance with EAD 330196-01-0604, *Plastic anchors made of virgin or non-virgin material for fixing of external thermal insulation composite systems with rendering* under the responsibility of an engineer experienced in anchorages.
- Verifiable calculation notes and drawings shall be prepared taking account of the loads to be anchored, the nature and strength of the base materials, the thickness of insulation and the dimensions of the anchorage as well as of the relevant tolerances.
- Proof of direct local application of load on the base material shall be delivered. The anchor shall only be used for the transmission of wind suction loads. All other loads such as dead load and restraints shall be transmitted by the adhesion of the relevant external thermal insulation composite system.

RAWLPLUG Insulation System R-TFIX-8S

Intended use
Specifications

Annex B 1

Installation:

The fitness for use of the anchor can only be assumed if the following conditions of installation are met:

- Anchor installation carried out by appropriately qualified personnel under the supervision of the person responsible for technical matters on site.
- Observation of the drill method (Drill holes in masonry made of vertically perforated clay bricks, lightweight aggregate concrete hollow blocks (LAC) and autoclaved aerated concrete may only be drilled using the rotary drill. Other drilling methods may also be used if job-site tests evaluate the influence of hammer or impact drilling.)
- Placing drill holes without damaging the reinforcement
- Temperature during installation of the anchor $\geq 0^{\circ}\text{C}$.
- Exposure to UV due to solar radiation of the anchor not protected by rendering 6 weeks.

Installation instructions – surface assembly

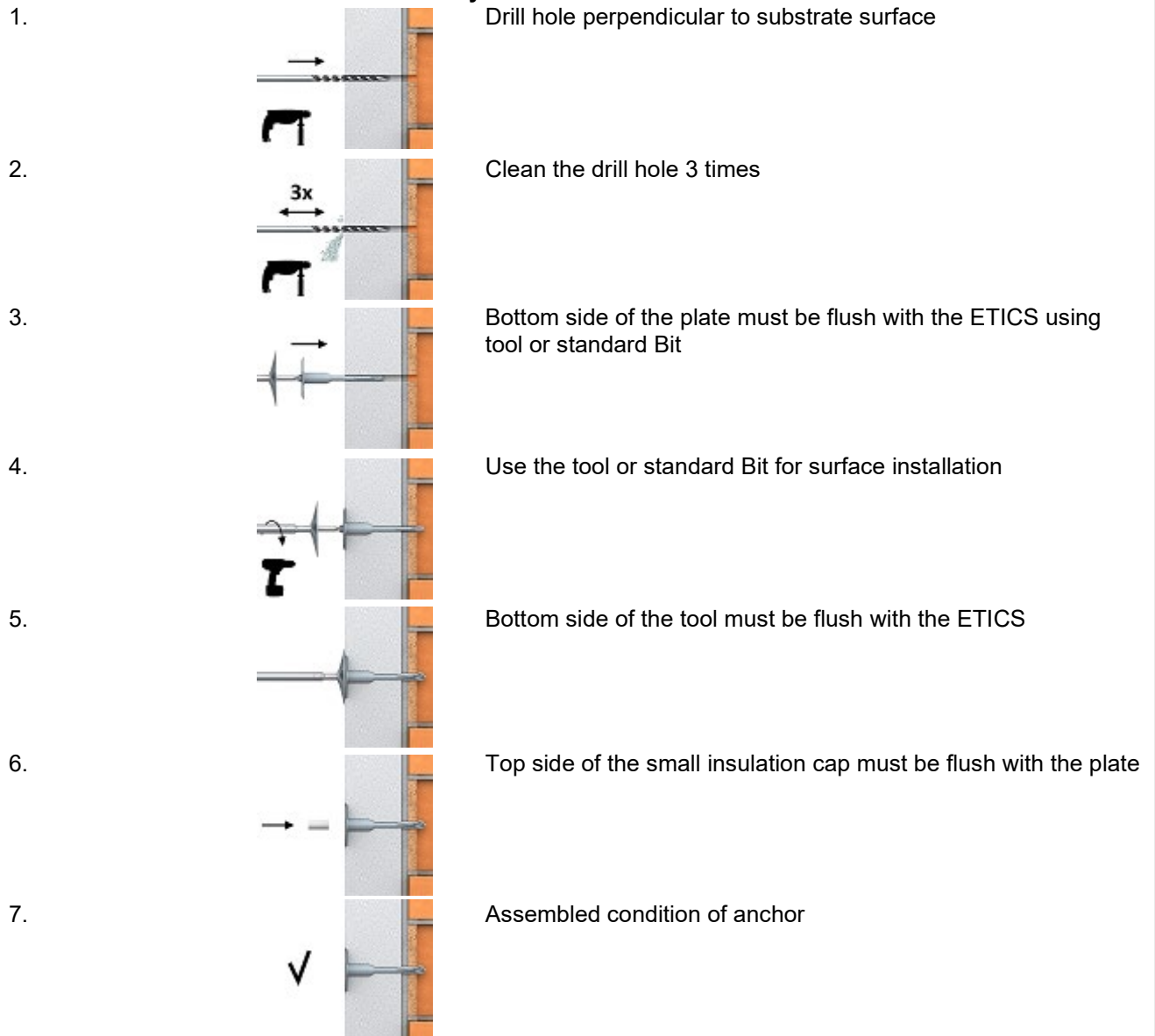



RAWLPLUG Insulation System R-TFIX-8S

Intended use
 Installation
 Installation instructions – surface assembly

Annex B 2

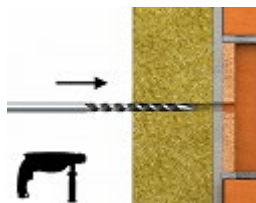
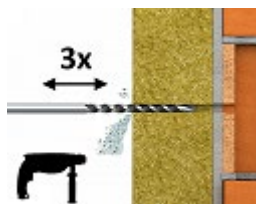
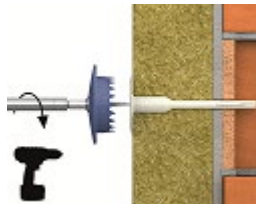
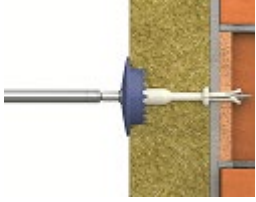
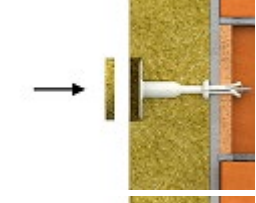
Installation instructions – countersunk assembly with R-TFIX – 8CS TOOL

1.  Drill hole perpendicular to substrate surface
2.  Clean the drill hole 3 times
3.  Bottom side of the plate must be flush with the ETICS using tool
4.  Use the tool for countersunk assembly.
Bottom side of the tool must be flush with the ETICS
5.  Top side of the insulation cap must be flush with the ETICS
6.  Assembled condition of anchor

RAWLPLUG Insulation System R-TFIX-8S

Intended use
Installation instructions – countersunk assembly

Annex B 3

Installation instructions – countersunk assembly R-TFIX-CSM TOOL

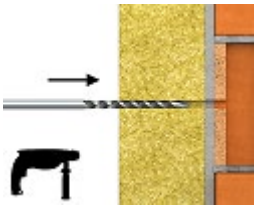
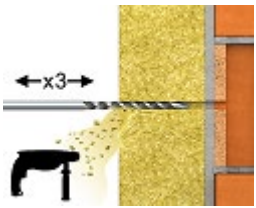
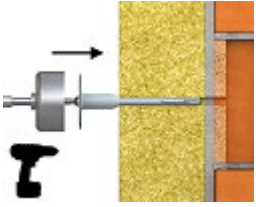
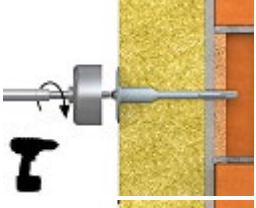
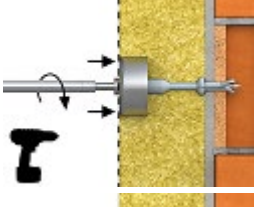
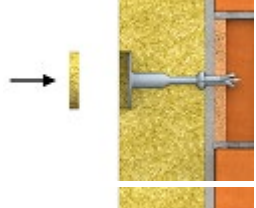
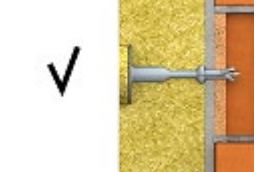
1.  Drill hole perpendicular to substrate surface
2.  Clean the drill hole 3 times
3.  Bottom side of the plate must be flush with the ETICS using tool
4.  Use the tool for countersunk assembly
5.  Bottom side of the tool must be flush with the ETICS
6.  Top side of the insulation cap must be flush with the ETICS
7.  Assembled condition of anchor

RAWLPLUG Insulation System R-TFIX-8S

Intended use
Installation instructions – countersunk assembly

Annex B 4

Setting tool

R-TFIX - 8S TOOL for surface assembly

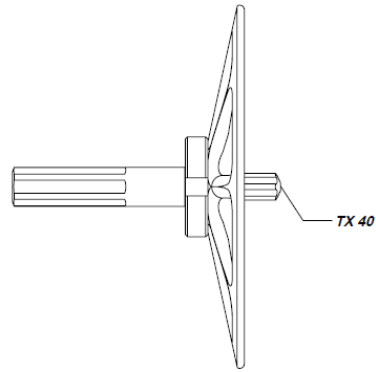
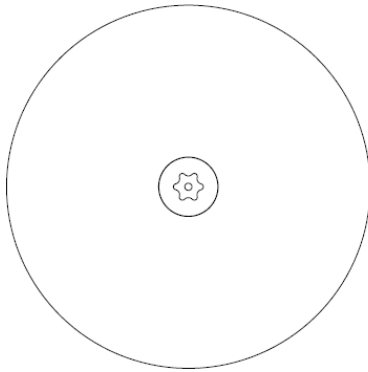

TX 40 = TORX ® 40 Bit

R-TFIX – 8CS TOOL for countersunk assembly

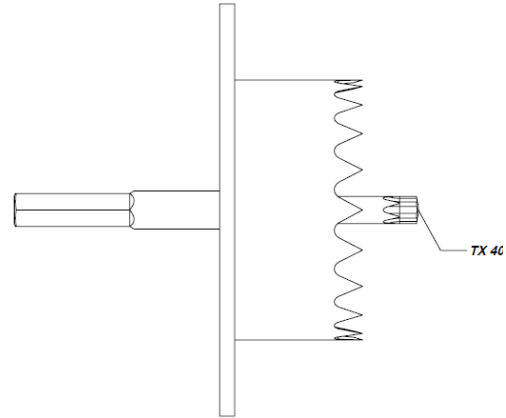
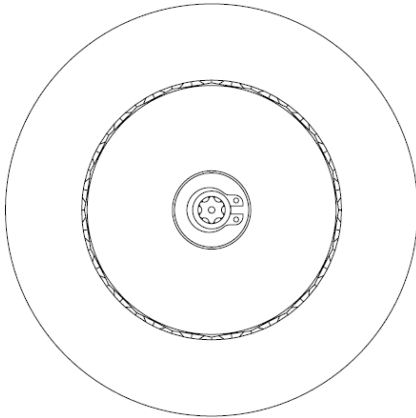

TX 40 = TORX ® 40 Bit

R-TFIX-TOOL-CSM TOOL for countersunk assembly

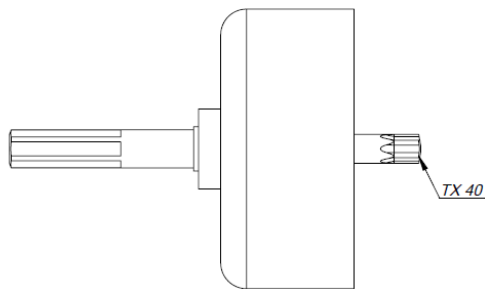
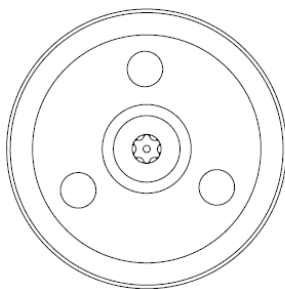

TX 40 = TORX ® 40 Bit

RAWLPLUG Insulation System R-TFIX-8S

Intended use
Setting tool

Annex B 5

Types of base materials

Table B1: Base materials

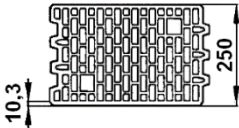
Base material	Use category	Bulk density [kg/dm ³]	Min. compressive strength β [N/mm ²]	General remarks	Drilling method
Concrete C 12/15 according to EN 206	A	-	-	-	Hammer drilling
Concrete C 16/20 – C 50/60 according to EN 206	A	-	-	-	Hammer drilling
External wall panel of concrete C 16/20 – C50/60 according to EN 206	A	-	-	Minimum thickness ≥ 40 mm	Hammer drilling or rotary drilling
Solid clay bricks according to EN 771-1	B	≥ 1.7	20	Vertically perforation up to 15%	Hammer drilling
Solid sand-lime bricks according to EN 771-2	B	≥ 1.8	30	Vertically perforation up to 15%	Hammer drilling
Vertically perforated clay bricks POROTHERM 17,5 P+D according to EN 771-1	C	≥ 0.9	15		Only rotary drilling
Lightweight aggregate concrete hollow blocks LAC according to EN 1520	D	≥ 1.2	4	-	Only rotary drilling
Autoclaved aerated concrete AAC 4 according to EN 771-4	E	≥ 0.4	4	-	Only rotary drilling

RAWLPLUG Insulation System R-TFIX-8S

Intended use
Base materials

Annex B 6

Installation

Table B2: Installation characteristics

Anchor type	R-TFIX-8S	
	A, B, C, D	E
Use category	A, B, C, D	E
Nominal diameter of drill bit d_o [mm]	8	8
Min. diameter of drill bit $d_{cut, min} \geq$ [mm]	8.2	8.2
Max. diameter of drill bit $d_{cut, max} \leq$ [mm]	8.45	8.45
Depth of drill hole - Surface assembly $h_1 \geq$ [mm]	35	75
Depth of drill hole - Countersunk assembly $h_1 \geq$ [mm]	45	85
Effective embedment depth $h_{ef} \geq$ [mm]	25	65

Table B3.1: Minimum thickness of base material, edge distance and anchor spacing

Anchor type	Minimum thickness of base material h [mm]	Minimum spacing s_{min} [mm]	Minimum edge distance c_{min} [mm]
	R-TFIX-8S	100	100

Table B3.2: Minimum thickness of external wall panel of concrete, edge distance and anchor spacing

Anchor type	Minimum thickness of base material h [mm]	Minimum spacing s_{min} [mm]	Minimum edge distance c_{min} [mm]
	R-TFIX-8S	40	100

Scheme of distance and spacing.

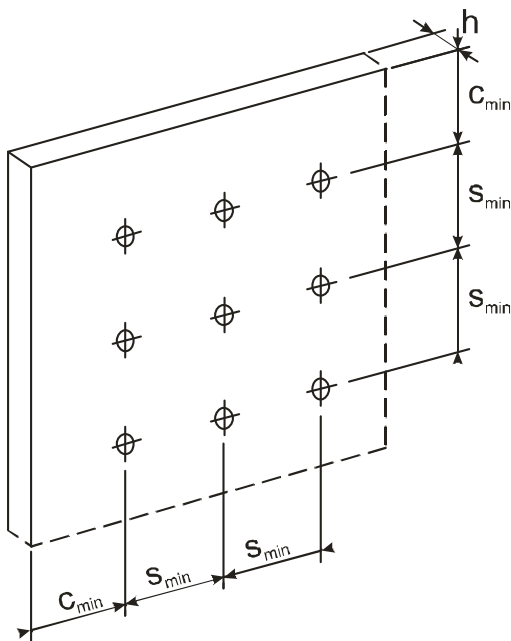

RAWLPLUG Insulation System R-TFIX-8S

Intended use
Installation characteristics
Edge and axial distances

Annex B 7

Table C1: Characteristic resistance to tension loads for single anchor

Base material	Use category	Bulk density [kg/dm ³]	Min. compressive strength β [N/mm ²]	R-TFIX-8S [kN]
Concrete C 12/15 according to EN 206	A			1.2
Concrete C 16/20 – C 50/60 according to EN 206	A			1.5
External wall panel of concrete C 16/20 – C50/60 according to EN 206	A			1.5
Solid clay bricks according to EN 771-1	B	≥ 1.7	20	1.5
Solid sand-lime bricks according to EN 771-2	B	≥ 1.8	30	1.5
Vertically perforated clay bricks POROTHERM 17,5 P+D according to ÖNORM B6124	C	≥ 0.9	15	0.9
Lightweight aggregate concrete hollow blocks LAC according to EN 1520	D	≥ 1.2	4	0.9
Autoclaved aerated concrete AAC 4 according to EN 771-4	E	≥ 0.4	4	1.2
Partial safety factor	$\gamma_M^{1)}$	2.0		

¹⁾in the absence of other national regulations

Table C2: Displacement of anchors R-TFIX-8S under tension loads

Base material	Tension load N_{Sk} [kN]	Displacement $\Delta\delta_N$ [mm]
Concrete C 12/15 according to EN 206	0.5	0.80
Concrete C 16/20 – C 50/60 according to EN 206	0.5	0.80
External wall panel of concrete C 16/20 – C50/60 according to EN 206	0.5	0.80
Solid clay bricks according to EN 771-1	0.5	0.74
Solid sand-lime bricks according to EN 771-2	0.5	0.67
Vertically perforated clay bricks POROTHERM 17,5 P+D according to EN 771-1	0.3	0.63
Lightweight aggregate concrete hollow blocks LAC according to EN 1520	0.3	0.70
Autoclaved aerated concrete AAC 4 according to EN 771-4	0.4	0.79

RAWLPLUG Insulation System R-TFIX-8S

Performances

Characteristic tension load
Displacement under tension load

Annex C 1

Table C3: Plate stiffness

Anchor type	Diameter of the anchor plate [mm]	Load resistance of the anchor plate [kN]	Plate stiffness [kN/mm]
R-TFIX-8S	60	2.04	0.6

Table C4: Point thermal transmittance

Anchor type	Insulation thickness h_D [mm]	Point thermal transmittance χ [K/W]
R-TFIX-8S Surface assembly	60 – 420	0.002
R-TFIX-8S Countersunk assembly	60 – 100	0.001
R-TFIX-8S Countersunk assembly	120 – 420	0.002

RAWLPLUG Insulation System R-TFIX-8S

Performances
 Plate stiffness
 Point thermal transmittance

Annex C 2



British Board of Agrément,
1st Floor Building 3
Hatters Lane
Croxley Park
Watford
WD18 8YG