



Designated according to The Construction Products (Amendment etc.) (EU Exit) Regulations 2020

UK Technical Assessment	UKTA-0836-22/6340 of 11/11/2022
Technical Assessment Body issuing the UK Technical Assessment:	British Board of Agrément
Trade name of the construction product:	KOELNER TFIX-8P Insulation Support
Product family to which the construction product belongs:	Area Code 33, Nailed-in plastic anchor for fixing of external thermal insulation composite systems with rendering in concrete and masonry
Manufacturer:	RAWLPLUG S.A. Kwidzyska 6 51-416 WROCLAW POLEN
Manufacturing plant(s):	Production Plant No. 2
This UK Technical Assessment contains:	13 pages including 3 annexes which form an integral part of this assessment
This UK Technical Assessment is issued in accordance with The Construction Products (Amendment etc.) (EU Exit) Regulations 2020 on the basis of:	UKAD 330196-01-0604 <i>Plastic anchors made of virgin or non-virgin material for fixing of external thermal insulation composite systems with rendering</i>

Communication of this UK Technical Assessment, including transmission by electronic means, shall be in full. However, partial reproduction may be made with the written consent of the British Board of Agrément. Any partial reproduction must be identified as such.

1 Technical description of the product

The KOELNER TFIX 8P insulation support is a nailed in anchor which consists of a plastic part of polypropylene (virgin material) and an accompanying specific nail of glass fibre reinforced polyamide (virgin material).

The anchor may in addition be combined with the anchor plates KWL 90, KWL 110 and KWL 140.

The product description is given in Annex A.

2 Specification of the intended use(s) in accordance with the applicable UK Assessment Document (hereinafter UKAD)

The performances given in Section 3 are only valid if the anchor is used in compliance with the specifications and conditions given in Annex B.

The verification and assessment methods on which this UK Technical Assessment is based lead to the assumption of a working life of the anchor of at least 25 years. The indications given on the working life cannot be interpreted as a guarantee given by the producer, but are to be regarded only as a means for choosing the right products in relation to the expected economically reasonable working life of the works.

3 Performance of the product and references to the methods used for its assessment

3.1 Mechanical resistance and stability (BWR 1)

Not relevant.

3.2 Safety in case of fire (BWR 2)

Not relevant.

3.3 Health, hygiene and the environment (BWR 3)

Not relevant.

3.4 Safety and accessibility in use (BWR 4)

Essential characteristic	Performance
Characteristic tension resistance	See Annex C 1
Edge distances and spacing	See Annex B 2
Point thermal transmittance	See Annex C 2
Displacements	See Annex C 2

3.5 Protection against noise (BWR 5)

Not relevant.

3.6 Energy economy and heat retention (BWR 6)

Essential characteristic	Performance
Point thermal transmittance	See Annex C 2

3.7 Sustainable use of natural resources (BWR 7)

No performance assessed.

4 Assessment and verification of constancy of performance (hereinafter AVCP) system applied

4.1 System of assessment and verification of constancy of performance

According to UKAD No. 330196-01-0604 and Annex V of the Construction Products Regulation (Regulation (EU) 305/2011 as brought into UK law and amended, the system of assessment and verification of constancy of performance (AVCP) 2+ applies.

5 Technical details necessary for the implementation of the AVCP system, as provided for in the applicable UKAD

Technical details necessary for the implementation of the AVCP system are laid down in the control plan deposited with the British Board of Agrément and made available to the UK Approved Bodies involved in the conformity attestation process.

5.1 UKCA marking for the product/ system must contain the following information:

- Identification number of the Approved Body
- Name/address of the manufacturer of the product/ system
- Marking with intention of clarification of intended use
- Date of marking
- Number of certificate of constancy of performance
- UKTA number.

On behalf of the British Board of Agrément



Date of Issue: 11 November 2022

Hardy Giesler
Chief Executive Officer



British Board of Agrément,
1st Floor Building 3
Hatters Lane
Croxley Park
Watford
WD18 8YG

ANNEXES

This annex applies to the product described in the main body of the UK Technical Assessment.

Installed anchor insulation support KOELNER TFIX 8P

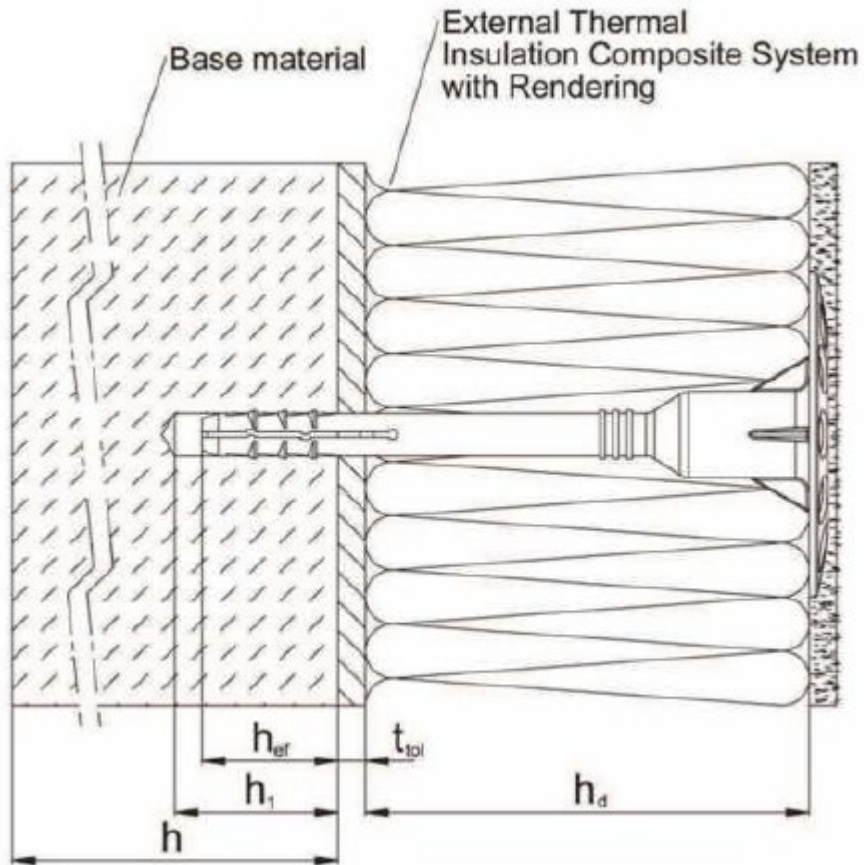

Insulation support KOELNER TFIX-8P

Product Description
Installed anchor

Annex A 1

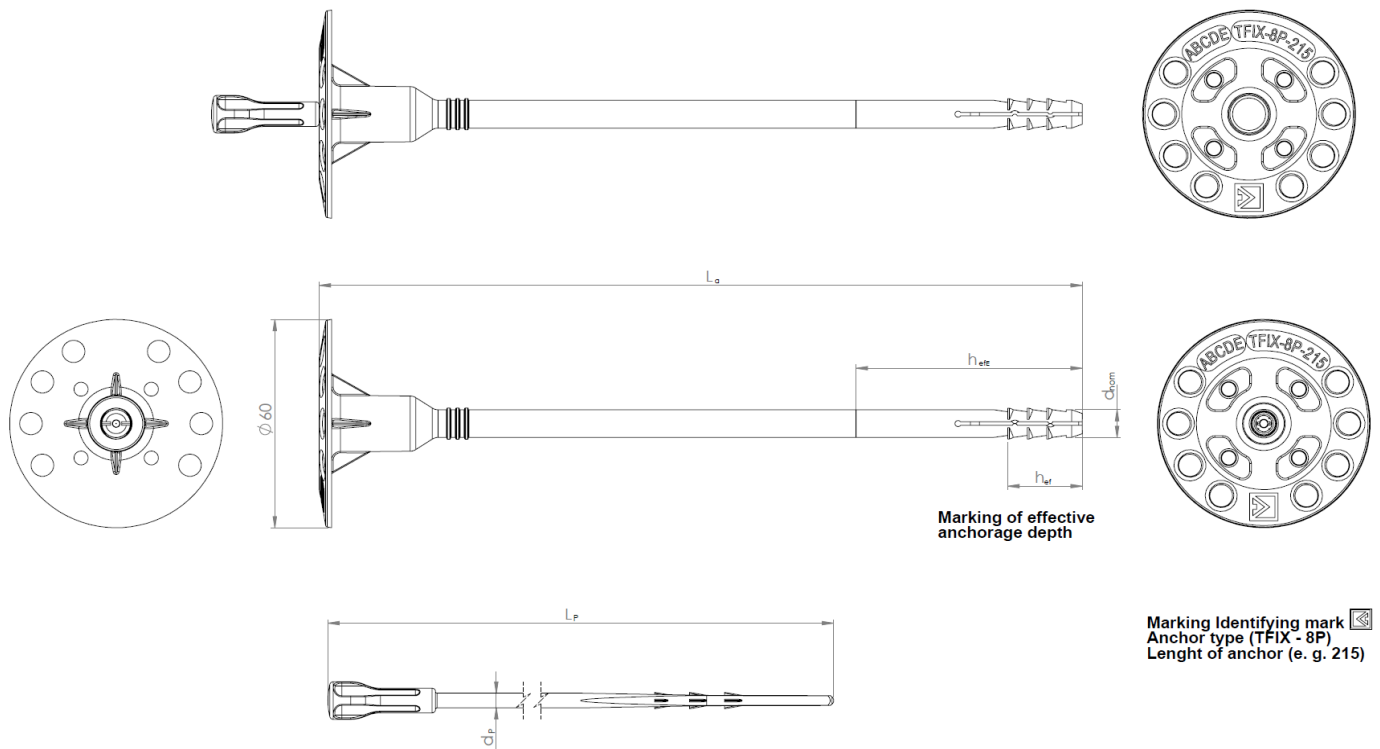

Fixing of ETICS in concrete and masonry
Table A1: Dimensions

Legend	Anchor sleeve	Accompanying expansion pin
h_{ef}	= effective anchorage depth	d_p [mm]
h	= thickness of member (wall)	
h_1 [mm]	= depth of drilled hole to deepest point [mm]	$4.35_{\pm 0,1}$
h_d	= thickness of insulation material	
t_{tol}	= thickness of equalizing layer or non-load-bearing coating	

Various lengths of the anchor are possible:
Determination of max thickness of insulation:

$$L_{a \min} = 115\text{mm}; L_{a \max} = 215\text{mm}$$

$$h_d = L_a - t_{tol} - h_{ef} \quad \text{z.B. } L_a = 135\text{mm}$$

$$t_{tol} = 10\text{mm}$$

$$h_d = 135\text{mm} - 10\text{mm} - 25\text{mm}$$

$$h_d = 100\text{mm}$$

Table A2: Materials

Designation	Material
Anchor sleeve	Polypropylene (virgin material)
Expansion pin	Polyamide, Glass Fibre reinforced (virgin material)

Insulation support KOELNER TFIX-8P

Product Description
Dimensions and materials

Annex A 2

KWL 140

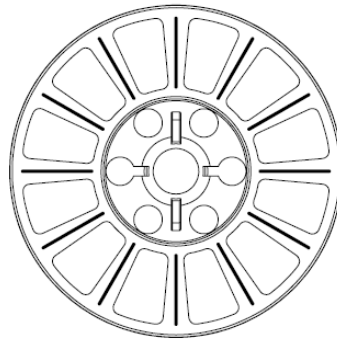

KWL 110

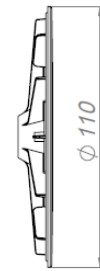
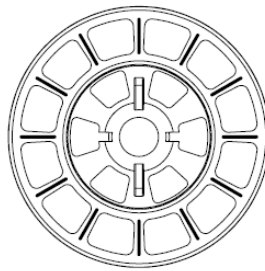

KWL 090

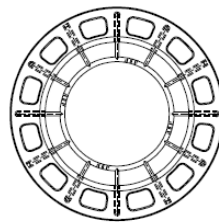

Table A.3: Additional plates, diameter and material

Plate	Diameter	Colour	Materials
KWL 90	90	nature	PA6 + GF, PP
KWL 110	110	nature	
KWL 140	140	nature	

Insulation support KOELNER TFIX-8P

Product Description
Additional plate

Annex A 3

Specifications

Anchorage subject to:

- The anchor may only be used for transmission of wind suction loads and shall not be used for the transmission of dead loads of the external thermal insulation composite system (ETICS).

Base materials:

- Normal weight concrete (use category A), according to Annex C1.
- Solid masonry (use category B), according to Annex C1.
- Hollow or perforated masonry (use category C), according to Annex C1.
- Lightweight aggregate concrete (use category D), according to Annex C1.
- Autoclaved aerated concrete (use category E), according to Annex C1.
- For other base materials of the use categories A, B, C, D and E the characteristic resistance of the anchor may be determined by job site tests acc. to EOTA Technical Report TR 051 Edition December 2016.

Temperature Range:

- 0°C to +40°C (max. short term temperature +40°C and max. long term temperature +24°C).

Design:

- The anchorages are designed under the responsibility of an engineer experienced in anchorages and masonry work with the partial safety factors $\gamma_M = 2.0$ and $\gamma_F = 1.5$ in absence of other national regulations.
- Verifiable calculation notes and drawings are prepared taking account of the loads to be anchored. The position of the anchors is indicated on the design drawings.
- Fasteners are only to be used for multiple fixings of ETICS.

Installation:

- Hole drilling by the drill modes according to Annex C1.
- Anchor installation carried out by appropriately qualified personnel and under the supervision of the person responsible for technical matters on the site.
- Installation temperature from 0°C to +40°C
- Exposure to UV due to solar radiation of the anchor not protected by rendering ≤ 6 weeks.

Insulation support KOELNER FIX-8P

Intended use
Specifications

Annex B 1

Table B.1: Installation parameters

			[mm]
Drill hole diameter		$d_0 =$	8
cutting diameter of drill bit		$d_{cut} <$	8.45
Base material	ABCD	depth of drilled hole to deepest point	$h_1 >$ 40
		effective anchorage depth	$h_{ef} \geq$ 25
	E	depth of drilled hole to deepest point	$h_1 >$ 80
		effective anchorage depth	$h_{ef} \geq$ 65

Table B.2: Anchor distances and dimensions of members

Use category		ABCD	E
Minimum spacing	$S_{min} =$ [mm]	100	100
Minimum edge distance	$C_{min} =$ [mm]	100	100
Minimum thickness of member	$h =$ [mm]	100	110

Scheme of distances and spacing

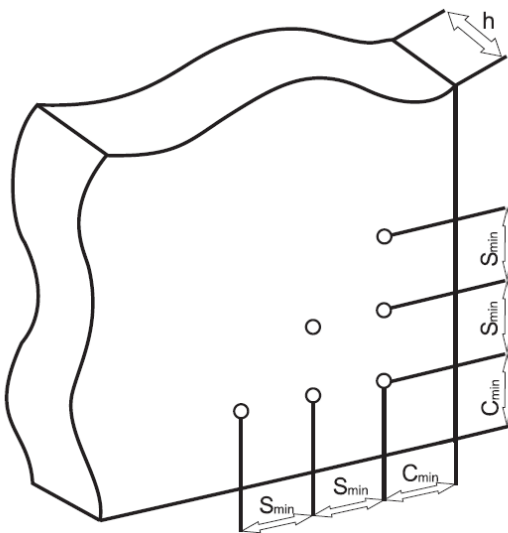

Insulation support KOELNER TFIX-8P

Intended use
Installation parameters and minimum distances

Annex B 2

Installation instructions

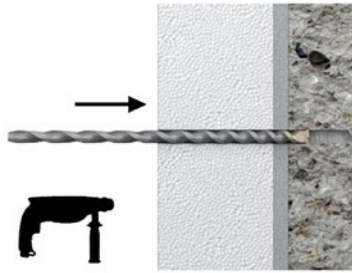

Drill a hole of required diameter and depth.

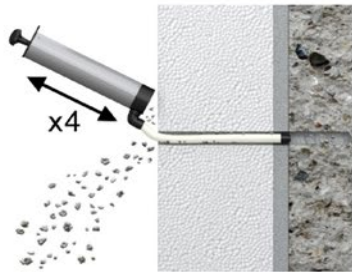

Blow out dust at least 4 times with a hand pump.

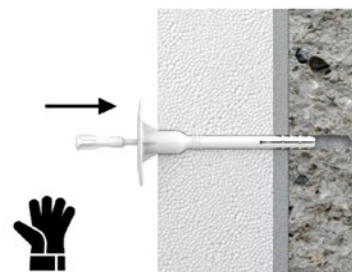

Insert TFIX-8P into the wellbore (this product should be pushed into the wellbore).

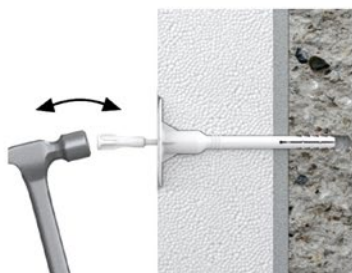

Lightly tap the plastic nail into the plastic sleeve until fixing is secure and flush with insulation material. Use the hammer for proper installation.

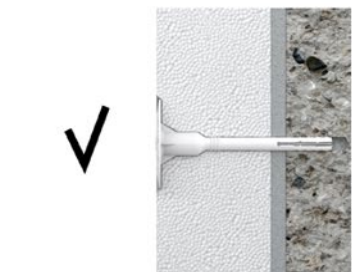

After installation.

Insulation support KOELNER TFIX-8P

Intended use
Installation instructions

Annex B 3

Table C.1: Characteristic resistance to tension loads N_{Rk} in concrete and masonry for a single anchor [kN]

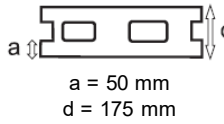
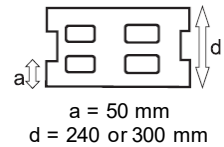
Base material	Bulk density class ρ [kg/dm ³]	Minimum compr.strength f_b [N/mm ²]	General remarks	Drilling method (2)	N_{Rk} [kN]
Concrete C12/15 In accordance with EN 206-1:2000		≥ 15	-	H	0.4
Concrete C16/20 - C50/60 In accordance with EN 206-1:2000		≥ 20	-	H	0.5
Clay brick Mz, In accordance with EN 771-1:2011	≥ 1.8	≥ 12	Vertically perforation up to 15%	H	0.5
Sand-lime solid bricks (calcium silicate) KS, In accordance with EN 771-2:2011	≥ 1.8	≥ 12	Vertically perforation up to 15%	H	0.5
Sand-lime solid bricks (calcium silicate) KSL, In accordance with EN 771-2:2011	≥ 1.4	≥ 12	Vertically perforation up to 15%, with outer web thickness of ≥ 20 mm	H	0.3
Perforated clay bricks In accordance with EN 771-1:2011	≥ 1.0	≥ 12	Vertically perforation more than 15%, and less than 50% (1)	D	0.3
Lightweight concrete solid block, Vbl In accordance with EN 771-3:2011	≥ 0.7	≥ 4	Proportion of handle hole to resting area up to 10%, Maximum size of handle hole: 110x45 mm	D	0.3
Lightweight concrete hollow block, Hbl, In accordance with EN 771-3:2011	≥ 0.8	≥ 2	The anchor shall be placed in a way that spreading part is anchored in the web of the brick; Thickness of outer web ≥ 50 mm;  	D	0.3
Lightweight aggregate Concrete, LA6 In accordance with EN 1520:2011, EN 771-3:2011	≥ 1.0	≥ 6	-	D	0.3
Autoclaved aerated concrete AAC 6, In accordance with EN 771-4:2011	≥ 0.7	≥ 6	-	D	0.5

- (1) Thickness of outer web ≥ 12 mm
(2) H = hammer drill, D= rotation drill

Insulation support KOELNER TFIX-8P

Performances
Characteristic resistance

Annex C 1

Table C.2: Point thermal transmittance in accordance with EOTA Technical Report TR 025: 2016 – 05

Anchor type	Thickness of insulation material h_D [mm]	Point thermal transmittance χ [W/K]
KOELNER TFIX-8P	50 - 180	0.000

Table C.3: Plate stiffness in accordance with EOTA Technical Report TR 026: 2016 – 05

Anchor type	Diameter of the plate [mm]	Load resistance of the anchor plate [kN]	Plate stiffness [kN/mm]
KOELNER TFIX-8P	60	1.38	0.3

Table C.4: Displacements

Base material	Bulk density class ρ [kg/dm ³]	Minimum compr. strength f_b [N/mm ²]	Tension load N [kN]	Displacements $\delta_m(N)$ [mm]
Concrete C12/15 in accordance with EN 206-1:2000		15	0.13	0.5
Concrete C16/20 - C50/60 in accordance with EN 206-1:2000		20	0.17	0.5
Clay brick Mz, in accordance with EN 771-1:2011	≥ 1.8	12	0.13	0.3
Sand-lime solid bricks (calcium silicate) KS, in accordance with EN 771-2:2011	≥ 1.8	12	0.10	0.4
Sand-lime solid bricks (calcium silicate) KSL, in accordance with EN 771-2:2011	≥ 1.4	12	0.10	0.4
Perforated clay bricks in accordance with EN 771-1:2011	≥ 1.0	12	0.10	0.7
Lightweight concrete solid block, Vbl in accordance with EN 771-3:2011	≥ 0.7	4	0.13	1.1
Lightweight concrete hollow block, Hbl, in accordance with EN 771-3:2011	≥ 0.8	2	0.10	0.2
Lightweight aggregate Concrete, LA6 in accordance with EN 1520:2011, EN 771-3:2011	≥ 1.0	6	0.10	0.3
Autoclaved aerated concrete AAC 6, in accordance with EN 771-4:2011	≥ 0.7	6	0.17	0.3

Insulation support KOELNER TFIX-8P

Performances

Point thermal transmittance, plate stiffness, displacements

Annex C 2



British Board of Agrément,
1st Floor Building 3
Hatters Lane
Croxley Park
Watford
WD18 8YG